

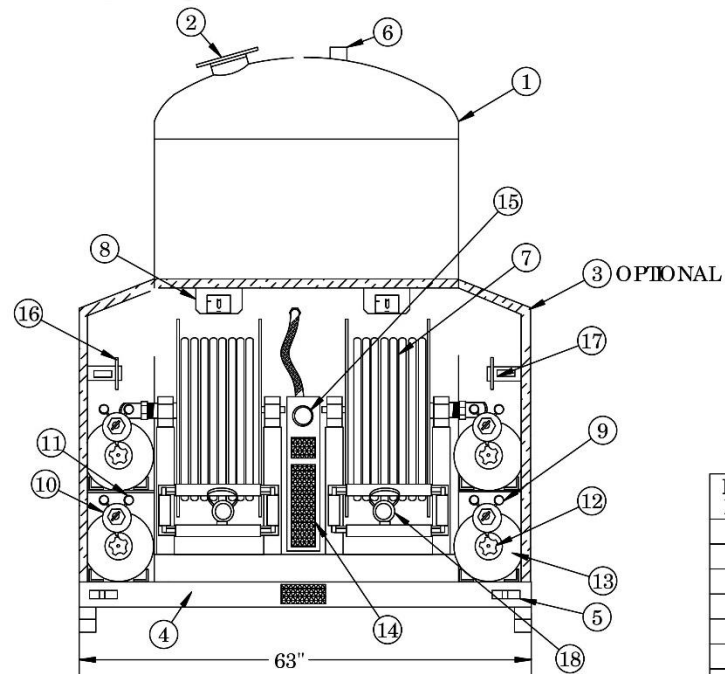

Quality is Behind the Diamond.

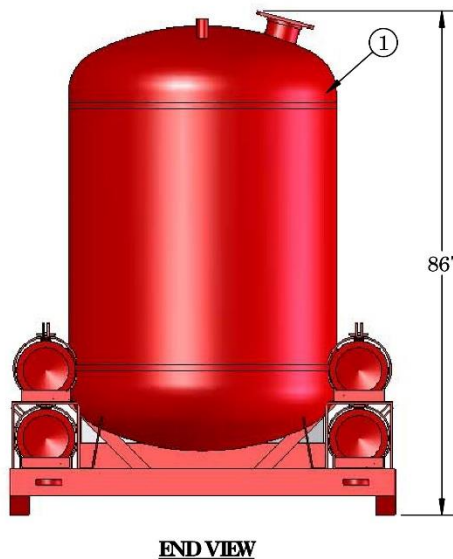
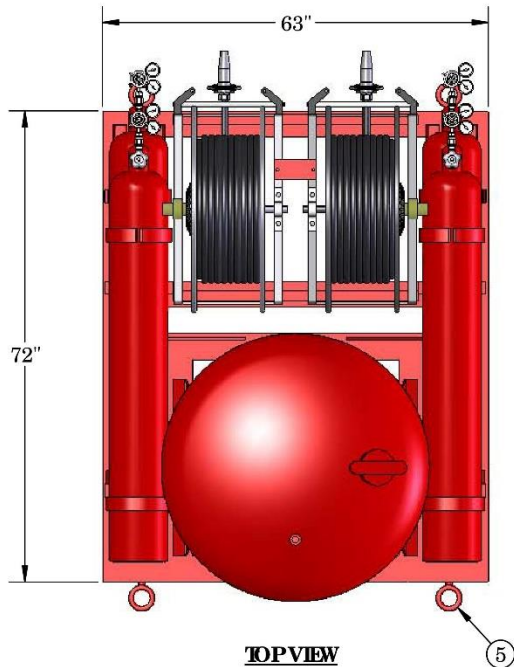

**AMEREX MODEL 906
3000 LB DRY CHEMICAL UNIT**

EMPTY WEIGHT- 3,375 lbs

FULL WEIGHT- 6,375 lbs

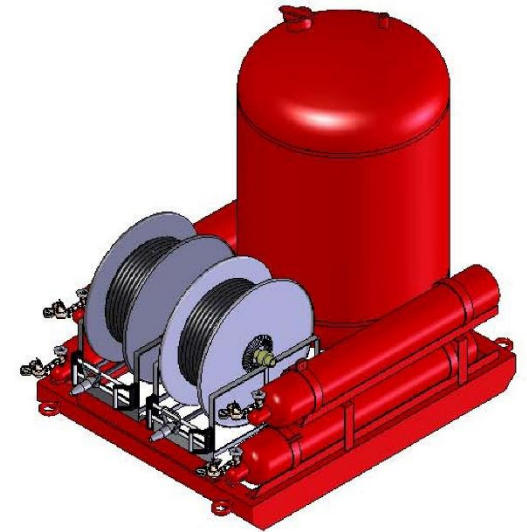

ISOMETRIC VIEW

ITEM NO.	UNIT DESCRIPTION
1	A.S.M.E CODE CYLINDER
2	4" FILLER CAP
3	REMOVABLE COWLING - OPTIONAL
4	SKID ASSEMBLY
5	TIE DOWN EYELET
6	250 POP-OFF
7	HOSE REEL MANUAL REWIND W/ 100FT 1" HOSE
8	REMOTE BLEED VALVE
9	REGULATOR PRESSURE GAUGE
10	NITROGEN REGULATOR
11	HIGH PRESSURE GAUGE
12	NITROGEN CYLINDER VALVE
13	NITROGEN CYLINDER
14	CONTROL CONSOLE
15	EXTINGUISHER PRESSURE GAUGE
16	MANUAL CONTROL VALVE-LEFT HOSE REEL
17	MANUAL CONTROL VALVE-RIGHT HOSE REEL
18	SHUTOFF